





# black mango.

interiors

## MARI DINING TABLE ASSEMBLY INSTRUCTIONS

No	LIST OF HARDWARE	Q.TY(pcs)
1	Bolts 6 x 45 	8
2	Plat Washers 6 	8
3	Spring Washers 6 	8
4	Allen key 	1

A



B

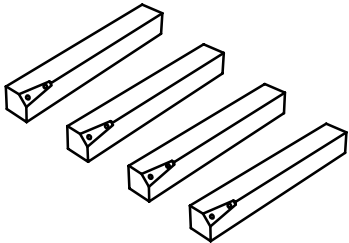

### ENQUIRIES

For product or warranty enquiries please email [team@blackmango.com.au](mailto:team@blackmango.com.au)

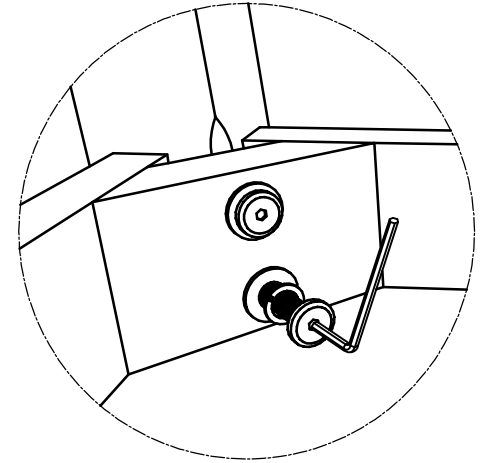
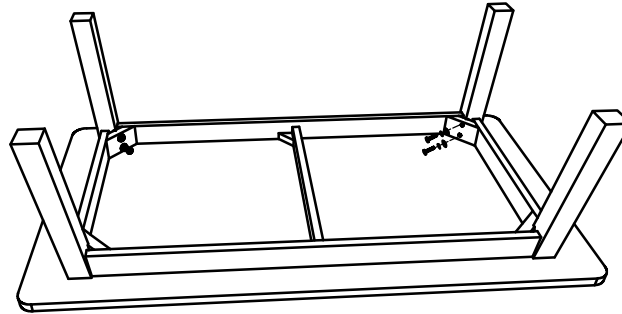

1

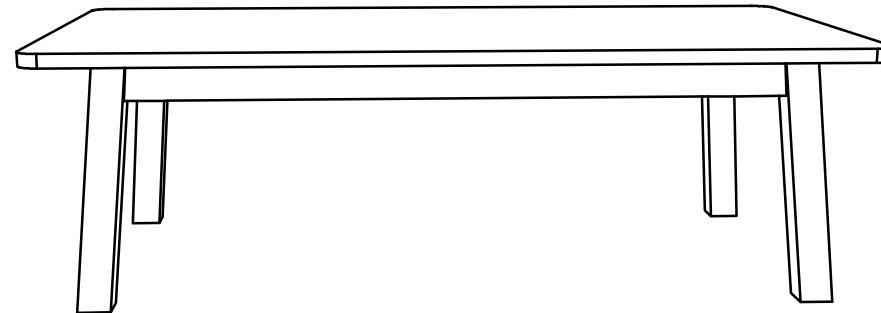

2